

AKU230

Digital, CMOS MEMS Microphone



Data Sheet

Part number(s)	AKU230
Package type	6-pin LGA top port
Data sheet revision	1.0
Release date	02 June 2011
Document number	DS25-1.0 AKU230 Datasheet
Notes	Specifications are subject to change without notice. Product photos and pictures are for illustration purposes only and may differ from the real product's appearance.

AKU230 Digital, CMOS MEMS Microphone

Key Features

- Monolithic CMOS MEMS Digital Microphone with PDM (pulse density modulation) output
- Highly-matched microphones in frequency and phase response for array applications
- Robust digital-output immune to RF/EM interference
- Output supports dual-microphone, single-wire multiplexing
- Industry standard microphone interface compatible with multiple codecs
- Low current power-down mode
- Lead-free surface-mountable and RoHS compliant
- Halogen-free in accordance with IEC61249-2-21
- Thin profile, SMT packaging
- Footprint-compatible to AKU2002 families
- Industry-standard package 3.76 x 4.72 x 1.25 mm³

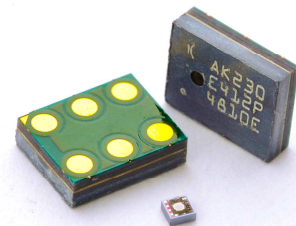

Typical Applications

- Microphone arrays
- Laptop, slate, tablet, AIO, UMPC, MID PC's
- Webcams, camera modules

General Description

The AKU230, Akustica's 4th generation of CMOS MEMS microphone, is a top ported, surface mountable, digital output microphone which can be used in any design that currently uses a 3.76mm x 4.72mm digital microphone footprint. Akustica's digital microphones are the world's first and only surface-mountable monolithic digital MEMS microphones that integrate an acoustic transducer, pre-amplifier, and sigma-delta modulator in a single chip of silicon that is only 0.7mm².

The robust digital output stream from the AKU230 is virtually immune to all forms of Radio Frequency Interference (RFI) and Electromagnetic Interference (EMI) allowing the microphone to be integrated anywhere on the platform regardless of proximity to displays, Wi-Fi antennae, or other sources of interference that would degrade the signal of conventional analog microphones. For the manufacturer, this translates to the highest degree of design flexibility and freedom, and ultimately faster time-to-market.

The output of the microphone is pulse density modulated (PDM), a single-bit digital output stream designed to enable the multiplexing of stereo microphone data onto a single wire. With a user selectable L/R channel option, the AKU230 is ideal for use in multiple microphone applications such as microphone arrays mounted on embedded camera modules in laptop PCs.

	AKU230 Digital, CMOS MEMS Microphone	Data Sheet
---	--	------------

Index of Contents

1. ABSOLUTE MAXIMUM RATINGS	4
2. STANDARD OPERATING CONDITIONS.....	4
3. ELECTRICAL AND ELECTRO-ACOUSTIC SPECIFICATIONS.....	4-6
3.1 Timing Characteristics	
3.2 Digital Logic Characteristics	
4. ACOUSTIC CHARACTERISTICS.....	6
4.1 Frequency Response	
4.2 IDD vs. VDD	
4.3 Sensitivity vs. VDD	
4.4 Sensitivity vs. CLK	
4.5 Sensitivity vs. Temperature	
5. PACKAGE	7
6. PIN-OUT AND CONNECTION DIAGRAMS	7-8
6.1 Pin Out	
6.2 Pin Description	
6.3 Typical Application Schematic	
7. MANUFACTURING NOTES	9
8. PART MARKING INFORMATION.....	9
9. ORDERING INFORMATION	10
10. REFERENCE DOCUMENTS	10
10.1 Application Notes	
10.2 Theory of Operation	
10.3 Measurement Information	
10.4 Glossary of Terms	
10.5 Reliability Tests	

	AKU230 Digital, CMOS MEMS Microphone	Data Sheet
---	--	------------

1. ABSOLUTE MAXIMUM RATINGS

Supply Voltage, V_{DD} to GND	5.5V
ESD Tolerance	
Human Body Model	2000V
Machine Model	200V
Storage Temperature Range	-40°C to 105°C

2. STANDARD OPERATING CONDITIONS

Operating Temperature Range	-40°C to 70°C
Within +/-3dB from 100Hz -10kHz	
Supply Voltage (V_{DD})	2.3V to 3.6V

3. ELECTRICAL AND ELECTRO-ACOUSTIC SPECIFICATIONS

Unless otherwise noted, test conditions are:
 $V_{DD} = 3V$ $T_a = 25^\circ C$ RH = 50%

Parameter	Note	Test Conditions	Min.	Typ.	Max.	Unit
Directivity	2		Omni-directional			
Frequency Range	2		50		22k	Hz
Signal to Noise Ratio (SNR)	2	$f_{in} = 1$ kHz, A-weighted, 20Hz-10kHz		56		dB
Sensitivity	1	1kHz, 94 dB SPL, full-scale=100% 1's density at PDM output of microphone	-30	-26	-22	dBFS
Total Harmonic Distortion (THD)	1	@ 115dB SPL, $f_{in} = 1$ kHz		2	10	%
Acoustic Overload Point	1				120	dB SPL
Power Supply Rejection (PSR)	1	Test signal on $V_{DD} = 217$ Hz, 100 mV _{DD}		57		dBFS
Part-to-part phase matching from nominal	2	$f_{in} = 1$ kHz			± 10	°
Current Consumption (with no load)	2	Clock > 1MHz	0.55		1.2	mA
	2	Clock off		11		μA
Power-up initialization	2	Data invalid time from clock on			20	ms

Note 1: Parameter 100% tested
 Note 2: Parameter guaranteed by design

3.1 Timing Characteristics

(Typical performance with load capacitance <20pF and a clock frequency of 2.8224 MHz)

	Data Valid	Data Sampled	L/R_SELECT Connected to
DATA_L	Falling clock	Rising clock	GND
DATA_R	Rising clock	Falling clock	V _{DD}

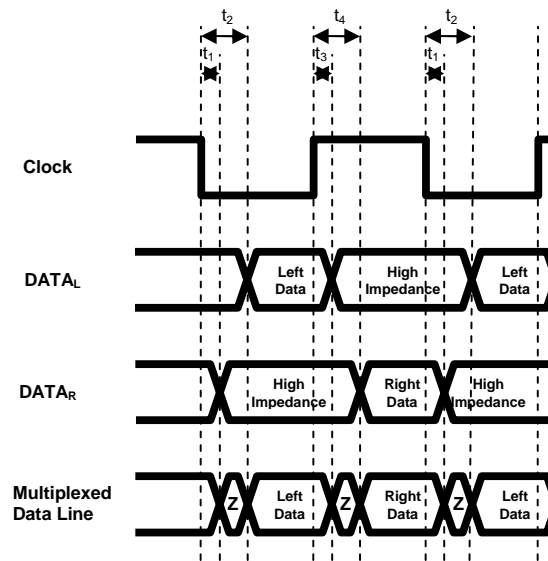

Output	Parameter	Typical Value	Description
DATA_R	t₁	6ns	Time from falling edge of clock until data becomes high impedance
DATA_L	t₂	33ns	Time from falling edge of clock until data becomes valid
DATA_L	t₃	6ns	Time from rising edge of clock until data becomes high impedance
DATA_R	t₄	29ns	Time from rising edge of clock until data becomes valid

3.2 Digital Logic Characteristics

(Typical performance with load capacitance <20pF and a clock frequency of 2.8224 MHz)

Symbol	Parameter	Min	Max	Units
$V_{IL\ MAX}$	Maximum level considered a logic 0		$0.4 \cdot V_{DD}$	V
$V_{IH\ MIN}$	Minimum level considered a logic 1	$0.5 \cdot V_{DD}$		V
$V_{OL\ MAX}$	Maximum level a driven output logic 0 can be		$0.05 \cdot V_{DD}$	V
$V_{OH\ MIN}$	Minimum level a driven output logic 1 can be	$0.95 \cdot V_{DD}$		V

4. DEVICE CHARACTERISTICS

4.1 Frequency Response

(Typical frequency response relative to input)

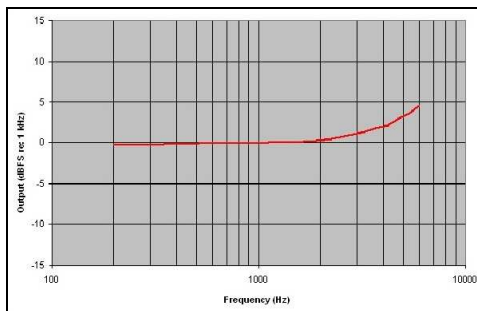

4.2 I_{DD} vs. V_{DD}

(Typical current consumption relative to supply voltage)

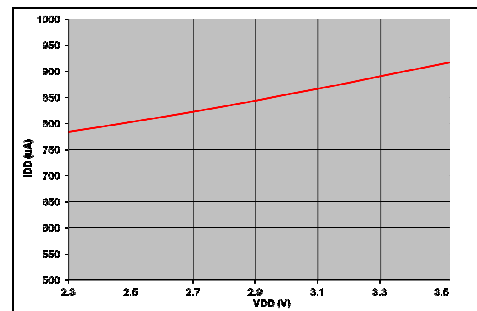

4.3 Sensitivity vs. V_{DD}

(Typical sensitivity changes relative to supply voltage)

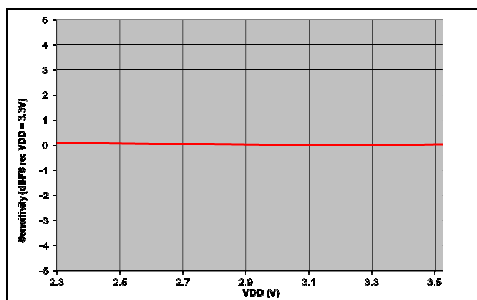

4.4 Sensitivity vs. CLK

(Typical sensitivity changes relative to clock frequency)

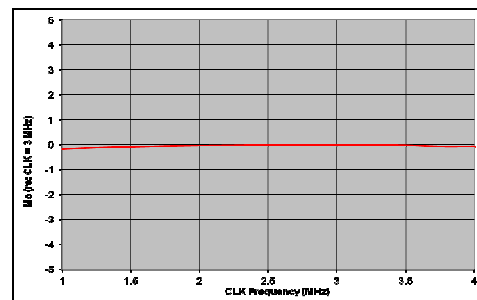

4. DEVICE CHARACTERISTICS (cont.)

4.5 Sensitivity vs. Temperature

(Typical sensitivity changes relative to temperature)

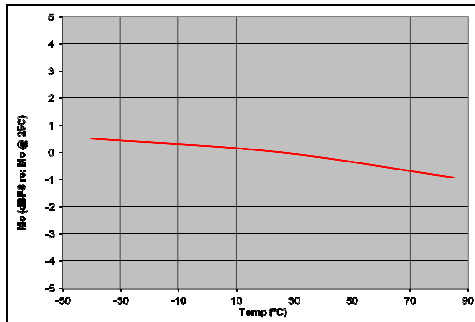

5. PACKAGE

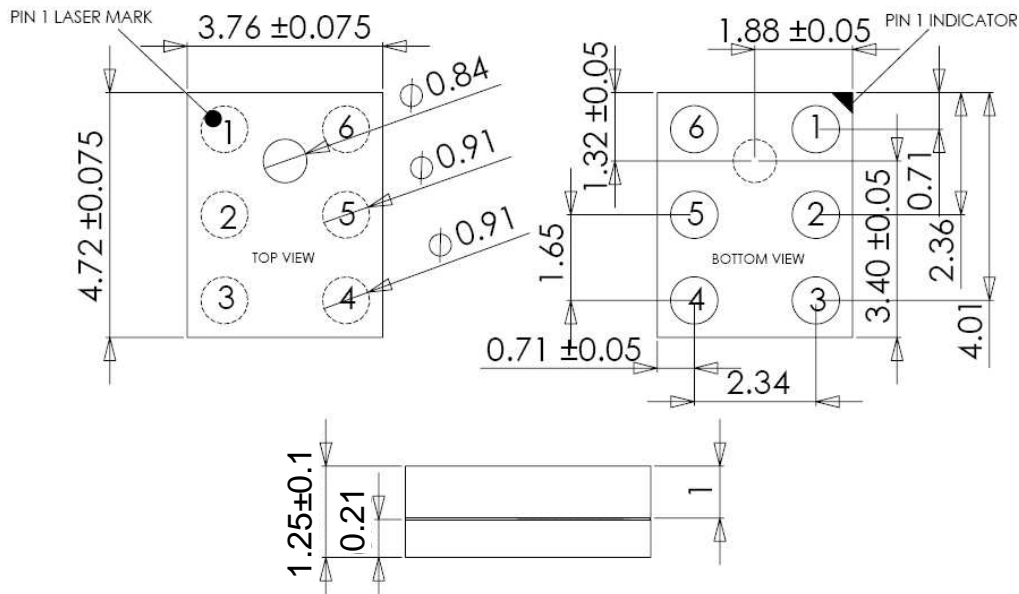

	AKU230 Digital, CMOS MEMS Microphone	Data Sheet
---	--	------------

6. PIN-OUT AND CONNECTION DIAGRAMS

6.1 Pin Out

(As viewed from **top** of package)

6-Pad LGA

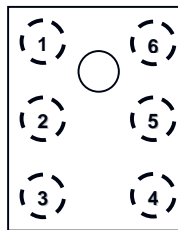

6.2 Pin Description

Pin	Name	Function
1	GND	Ground
2	L/R SELECT	Left/right select
3	N/C	Reserved for future function (tie to ground)
4	CLK	Clock input to microphone
5	DATA	PDM data output
6	V _{DD}	Power supply and I/O voltage for microphone

6.3 Typical Application Schematic

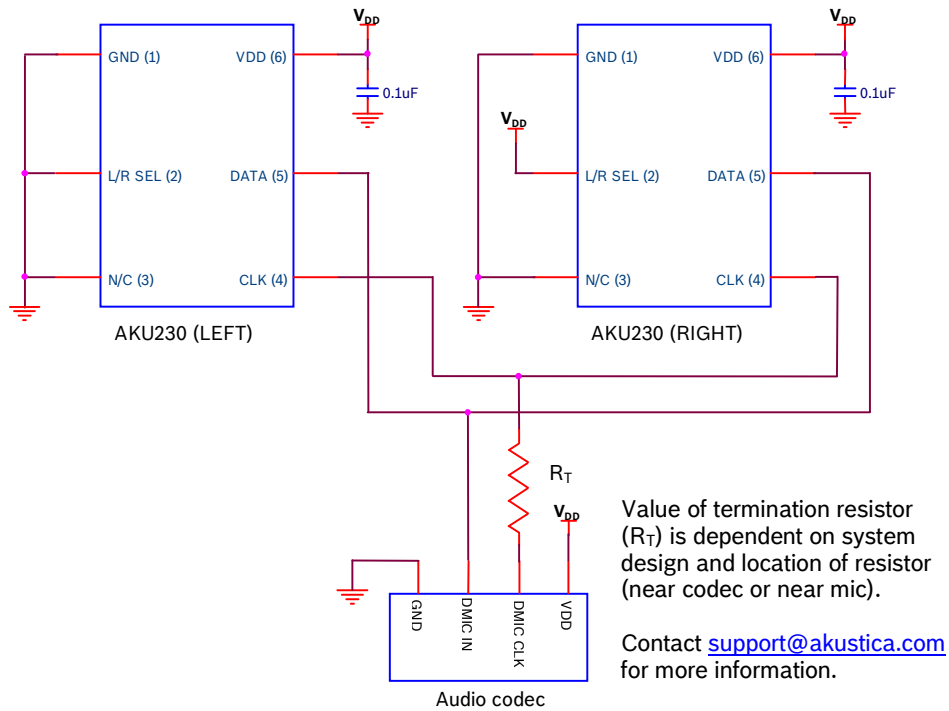

7. MANUFACTURING NOTES

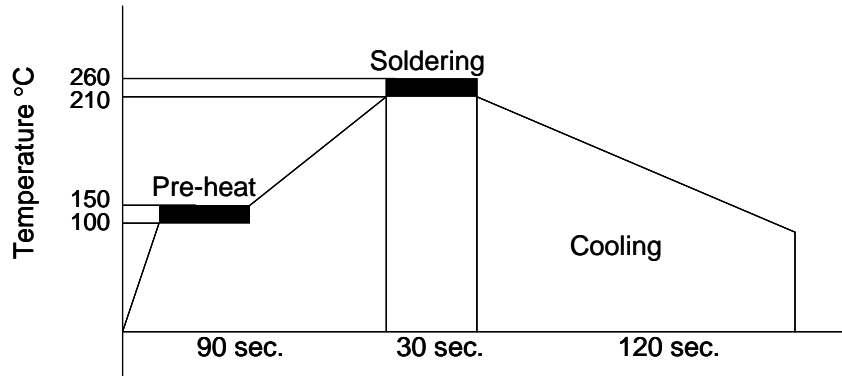

Recommended lead-free solder reflow profile

Assembly notes:

Solder reflow	260°C maximum for a maximum of 30 seconds
Cleaning	Do not wash after reflow. Do not use pressurized air to clean or aid in assembly.
Part Handling	Do not blow air into acoustic port or use vacuum pick-up head over acoustic port in package.

8. PART MARKING INFORMATION

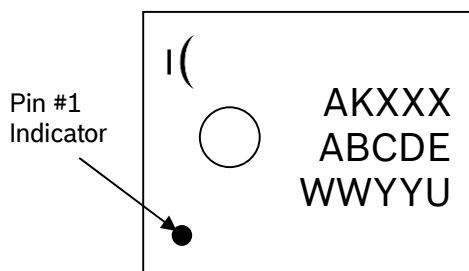

Line 1: Part code
 Line 2: Lot code
 Line 3: WW = Work week
 YY = Year code
 U = Assembly facility code

	AKU230 Digital, CMOS MEMS Microphone	Data Sheet
---	--	------------

9. ORDERING INFORMATION

Part Number	Description	Part Code	Package	Shipping Method	Standard Quantity
AKU230R	Digital MEMS Microphone	AK230	6 Pad LGA	13" Reel	4800
AKU-EP1-Digital	Evaluation Platform	EP1	Board	Box	1
AKU-IQC3-4x5	Incoming Quality Tester	IQC3	Fixture	Box	1
AKU-UQC	Universal Quality Tester	UQC	Fixture	Box	1

Akustica, Inc.
2835 E Carson St. Suite 301
Pittsburgh, PA / USA 15203

sales@akustica.com
www.akustica.com

Modifications reserved | Printed in USA
Specifications subject to change without notice

	AKU230 Digital, CMOS MEMS Microphone	Data Sheet
---	--	------------

10. REFERENCE MATERIALS

10.1 Application Notes

AN44 - AKU230 Microphone Module Design Guide

10.2 Theory of Operation

The AKU230 digital output microphone is a condenser microphone which has a structure consisting of a diaphragm (1) and a backplate (3), separated by an air gap (2), forming a parallel plate capacitor as shown. The nominal capacitance of the microphone can be determined by $C = \epsilon A/d$ where:

ϵ = the permittivity of free space
 A = area of the diaphragm
 d = airgap spacing

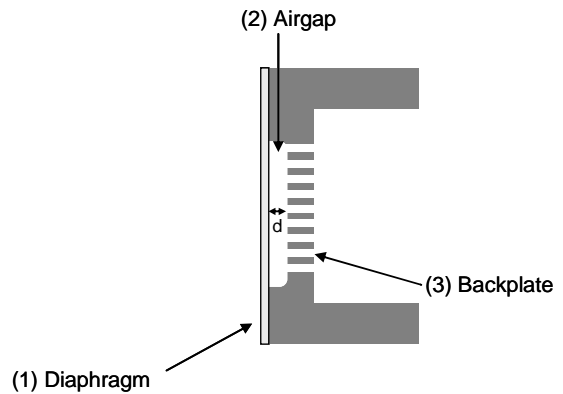

Sound pressure impinges on the diaphragm. The deflection of the diaphragm in response to sound causes the capacitance to vary. The variable capacitance is converted into an analog voltage signal which is amplified by the on-chip output amplifier. A 4th-order sigma-delta modulator converts the analog voltage from the output amplifier into a single-bit digital signal.

10.3 Measurement Information

Measuring Signal to Noise Ratio

The Signal to Noise Ratio (SNR) is the ratio of the output due to a 1 kHz, 94 dB SPL input signal to the Digital Noise Floor of the microphone. It is measured at the output of the sigma delta modulator. To measure the digital noise floor, the microphone is placed in a sound isolation box. The power spectral density (PSD) is measured and A-weighted. The A-weighted PSD is integrated over the audio band. The square root of the integrated value is the output Digital Noise Floor of the microphone. Both the SNR and Digital Noise Floor are usually quoted in dB.

	AKU230 Digital, CMOS MEMS Microphone	Data Sheet
---	--	------------

10.4 Glossary of Terms

A-weighting: The A-weighting filter is designed to approximate the variation in human ear sensitivity over the audio band at low sound pressure levels and is used to improve the correlation of a measured device noise level to the noise level perceived by the human ear.

dB (Decibel): A decibel (dB) is ten times the logarithm of a power ratio of two quantities. For linear quantities such as pressure and voltage, the decibel level is calculated using the formula $dB = 20 \cdot \log(\text{Value1}/\text{Value2})$. Value1 is usually a measured quantity and Value2 is usually a standard reference quantity that is measurement dependent. In order to calibrate a specification given in dB, you must know the reference value.

Frequency Response: The frequency response indicates the sensitivity of the microphone over a given frequency range.

Sound Pressure Level (SPL): The sound pressure level is an expression of loudness in dB SPL. The reference value is 20 μ Parms which is the lower threshold of hearing of a healthy human ear at 1 kHz. A sound pressure of 1 Parm corresponds to a sound pressure level of 94 dB SPL. As a reference, the sound pressure level of a noisy office environment would be roughly 75 dB SPL.

Power Supply Rejection Ratio (PSRR): The PSRR supplies a quantitative measurement of how ripples in the power supply voltage affect the output voltage of a component. It is calculated as the ratio of the power supply voltage change to the output voltage change of the component.

	AKU230 Digital, CMOS MEMS Microphone	Data Sheet
---	--	------------

10.5 Reliability Tests

	Test	Test Condition
1	Cold Storage Test	Temperature = -40C, 1000 hours
2	Hot Storage Test	Temperature = 105C, 1000 hours
3	Humidity	Temperature = 85C RH = 85%, 1000 hours
4	Thermal Cycle	100 Cycles, -40 to +125C, 15min soaks, <30sec ramps
5	Vibration	Sinusoidal Vibration, 20-2000Hz, 4min sweeps, 16min along each of 3 axis, amplitude 3 limits of 20G and 0.06"
6	Mechanical Shock	10,000 G shocks, 5 impacts along each of 6 axes
7	Drop Test	Using 150gm aluminum fixture, 3 drops along each of 6 axes (total 18 drops) from 1.5m height onto concrete drop surface.
8	ESD (HBM)	+/-2000V, 1 discharge for each polarity, 11 pin combinations, 22 total discharges per microphone
9	ESD (MM)	+/- 200V, 1 discharge for each polarity, 11 pin combinations, 22 total discharges per microphone
10	ESD (IEC 61000-4-2)	+/- 15kV, air discharge with DUT under bias, 3 discharges for each polarity
11	Moisture Sensitivity Level	24 hour bake at 125C, followed by 168 hours at 85C, 85%RH, followed by 3 passes solder reflow (MSL Level 1)